

# R-Go Flex Read

## RGODOFRTR

---

English manual	p.2
----------------	-----

---

Deutsche Anleitung	p.5
--------------------	-----

---

Manuel en français	p.8
--------------------	-----

---

Nederlandse handleiding	p.11
-------------------------	------

---

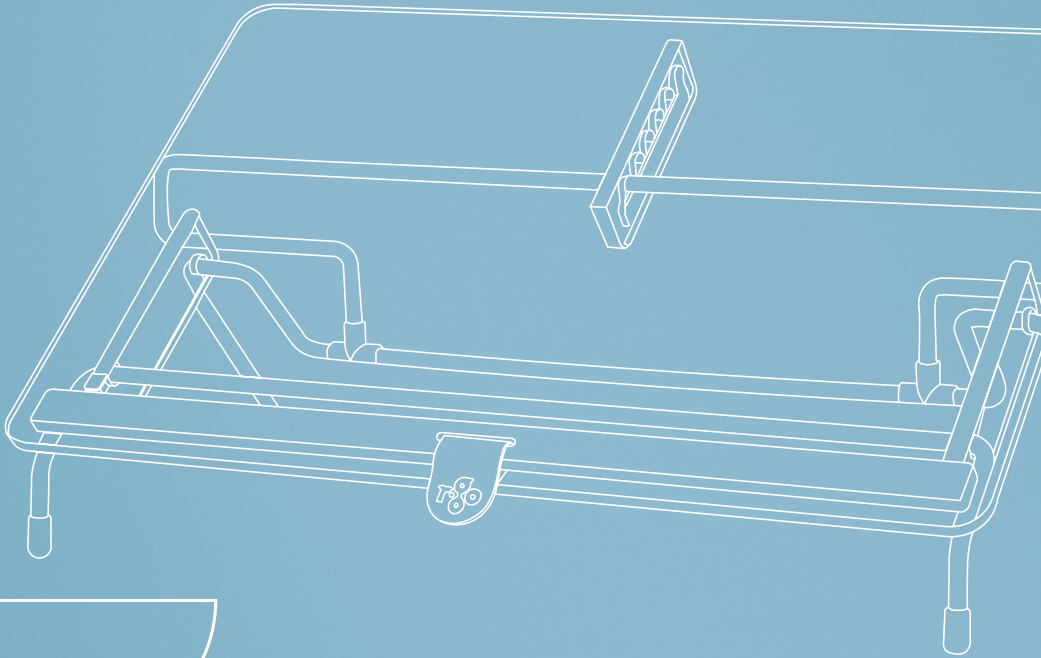

# ergonomic document holder

R-Go Flex Read

# Setup

---

Step A

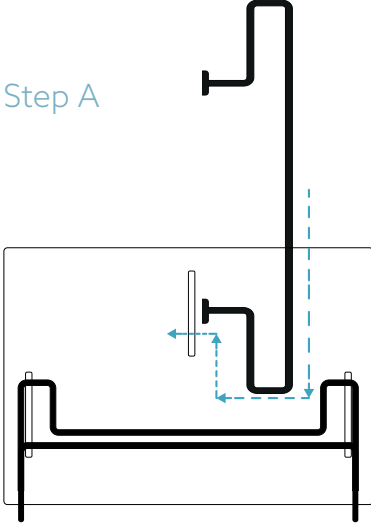

Step B

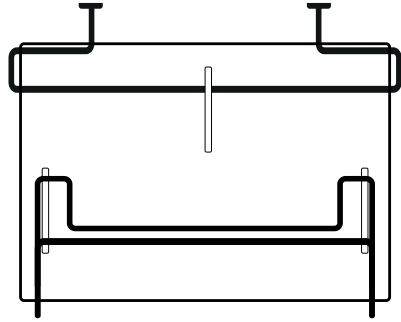

Step C

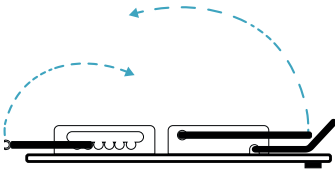

Step D

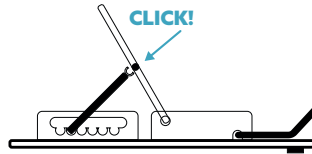

Step E

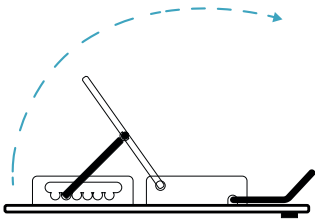

Step F

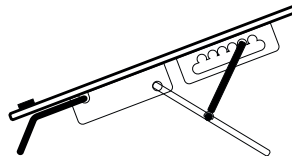

# Final product

---

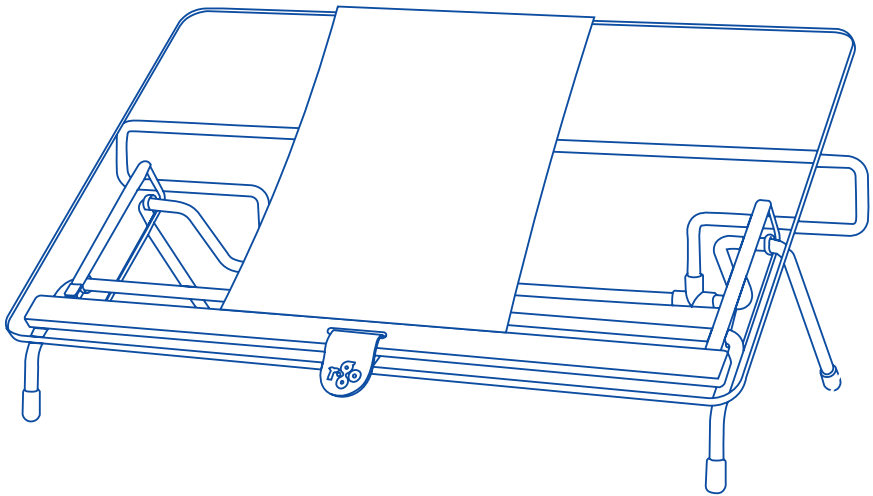

For more information  
about this product,  
scan the QR code!  
[https://r-go.tools/flexread\\_web\\_en](https://r-go.tools/flexread_web_en)

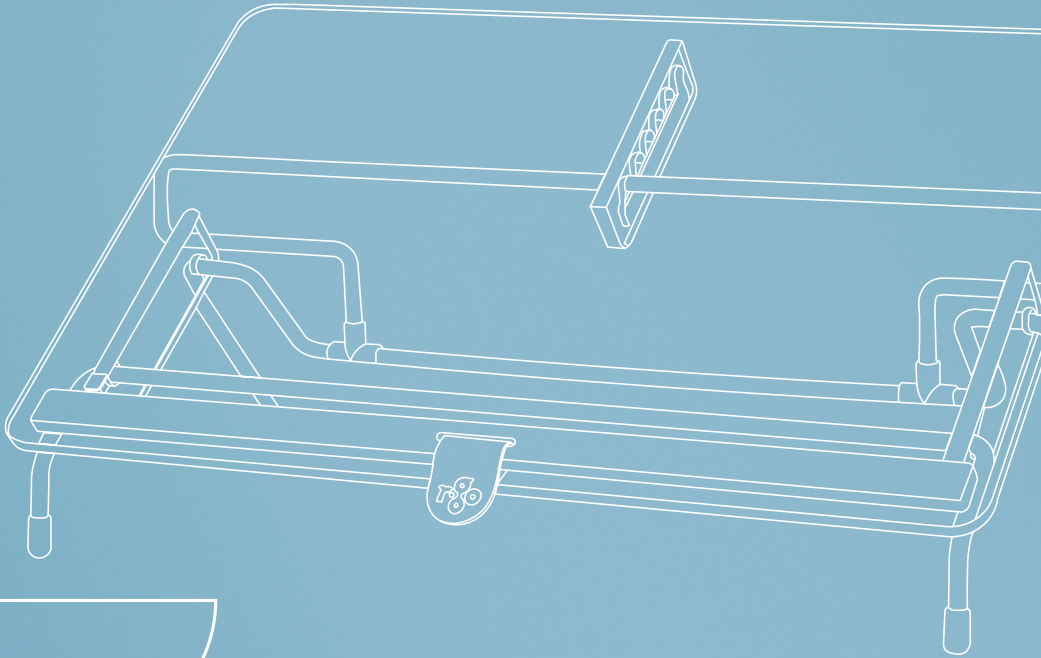

# Ergonomischer Dokumenten- halter

R-Go Flex Read

# Installation

---

Schritt A

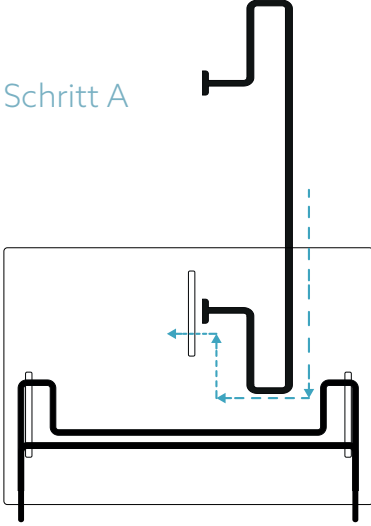

Schritt B

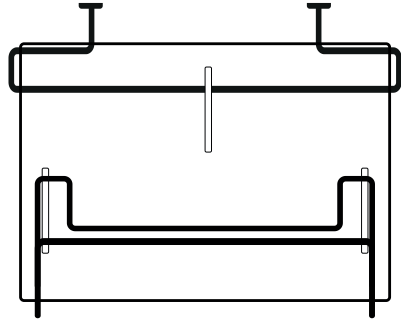

Schritt C

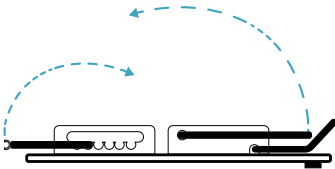

Schritt D

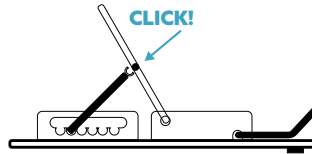

Schritt E

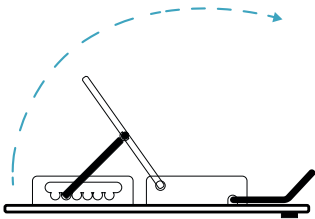

Schritt F

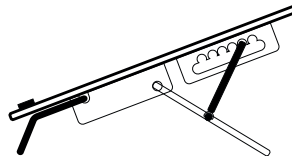

# Das endgültige Produkt

---

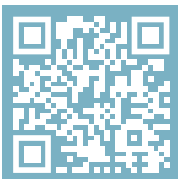
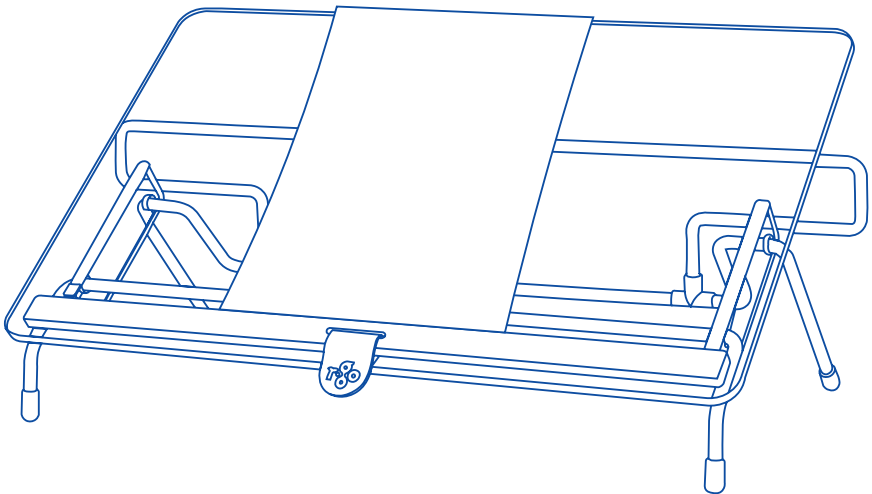

Für weitere Informationen  
über dieses Produkt,  
scannen Sie den QR-Code!  
[https://r-go.tools/flexread\\_web\\_de](https://r-go.tools/flexread_web_de)

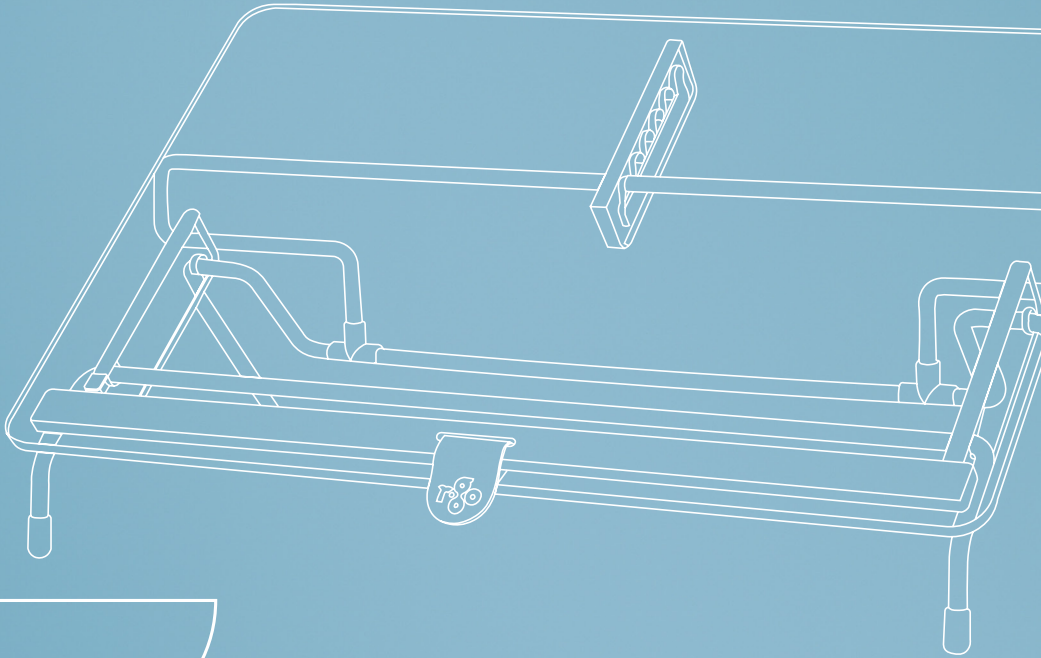

# porte- documents ergonomique

R-Go Flex Read



# Mise en place

---

Etape A

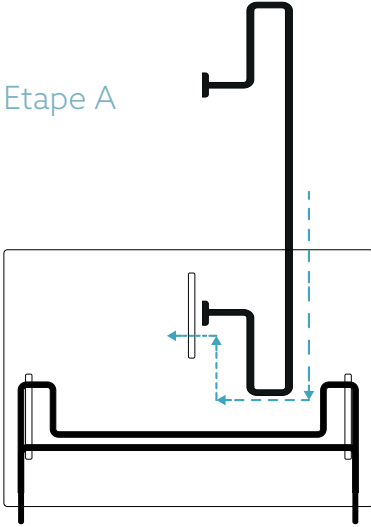

Etape B

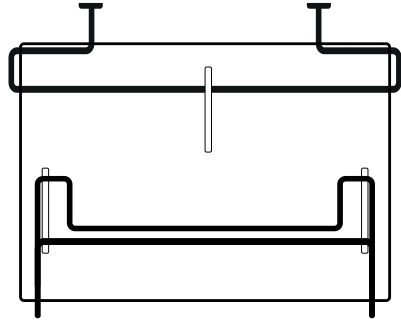

Etape C

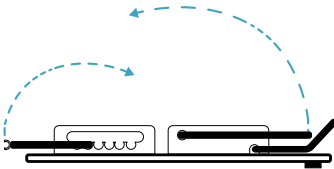

Etape D

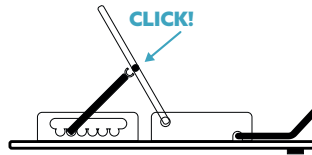

Etape E

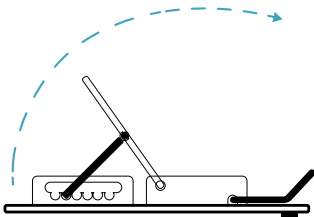

Etape F

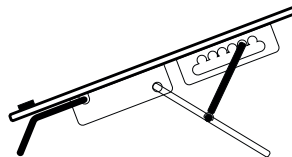

## Produit final

---

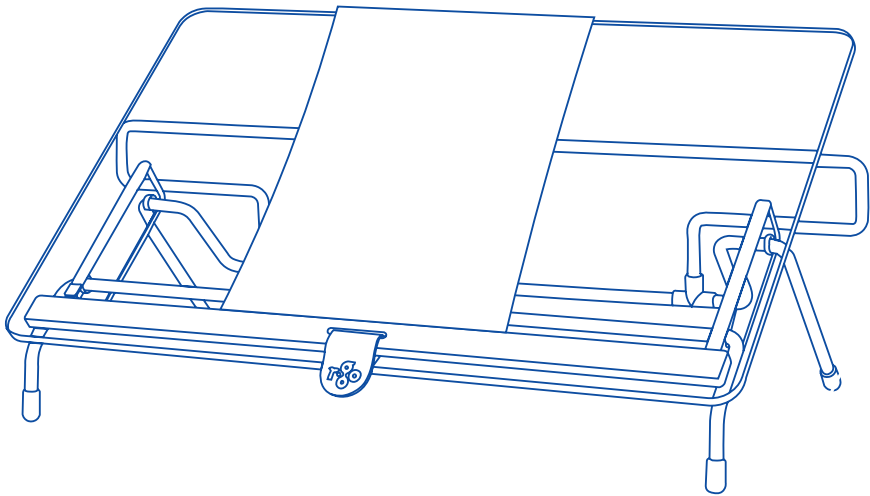

Pour plus d'informations  
sur ce produit,  
scannez le code QR!  
[https://r-go.tools/flexread\\_web\\_fr](https://r-go.tools/flexread_web_fr)



# ergonomische document- houder

R-Go Flex Read

# Installatie voor gebruik

---

Stap A

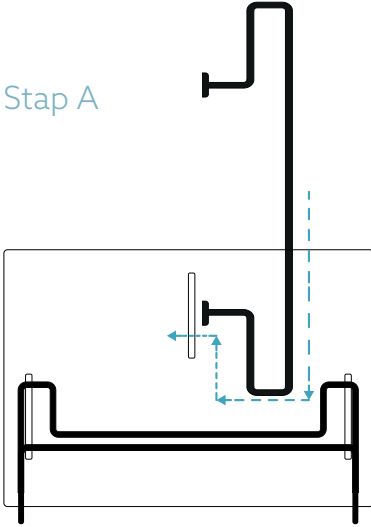

Stap B

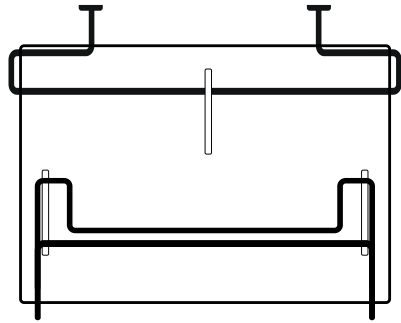

Stap C

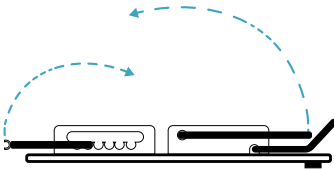

Stap D

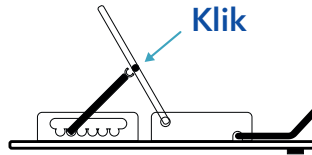

Stap E

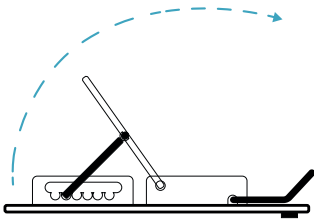

Stap F

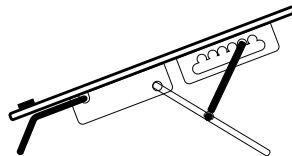

# Eindproduct

---

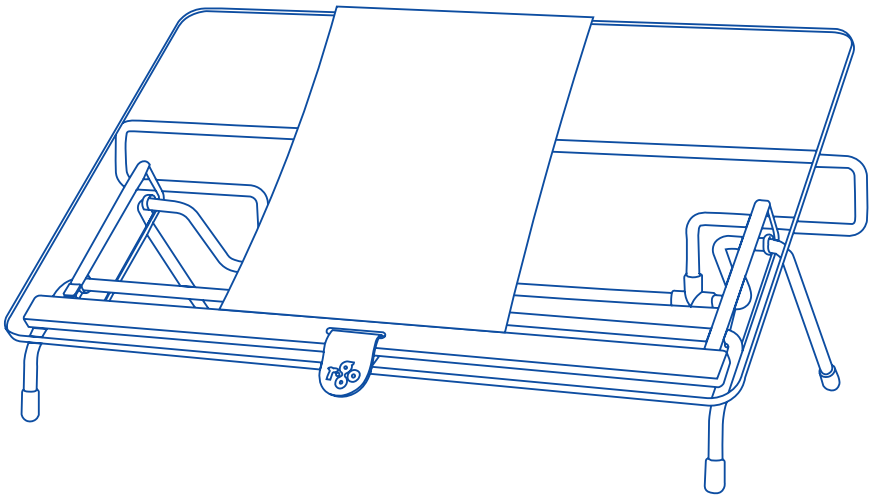

Scan de QR-code voor  
meer informatie over  
dit product!  
[https://r-go.tools/flexread\\_web\\_nl](https://r-go.tools/flexread_web_nl)